

REVISION RECORD

| REV | ECN | DESCRIPTION | DRFT | DATE |
|-----|-----|-------------|------|------|
|-----|-----|-------------|------|------|

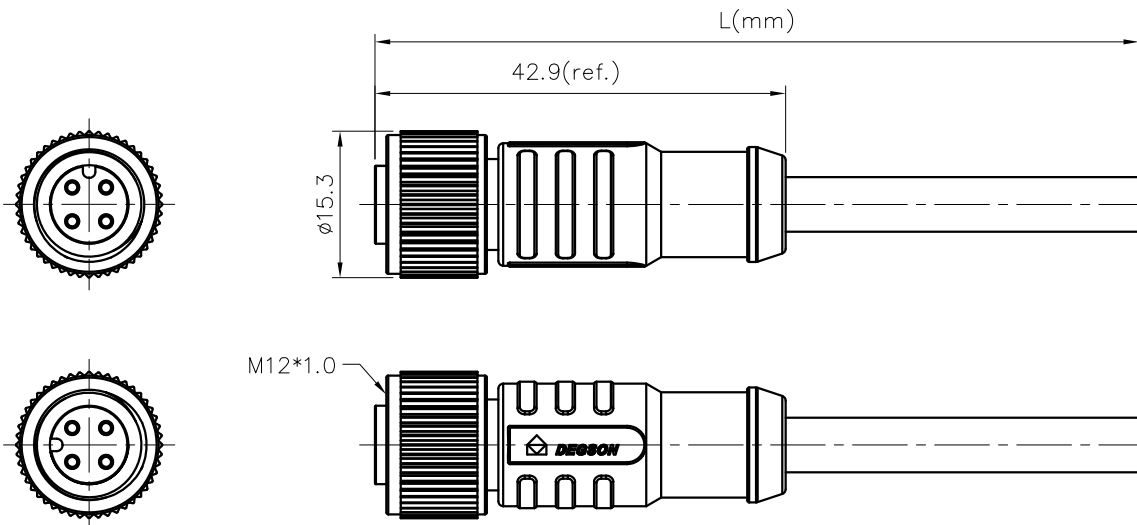



PM-M12X-XXP-FF-SL8XXX-00A(H)

Coding: A,B,D

Pin number: 03,04,
05,06,08,
10,12,17

Cable jacket:
A: PVC UL2517;
B: PUR UL20549
C: PVC UL2517 For UL Approve
D: PUR UL20549 For UL Approve

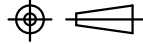
Cable length L:
01: 1M
...
99: 99M
The line grows business trip:
01~05m: ± 50mm
06~10m: ± 100mm
11~30m: ± 200mm
31~99m: ± 500mm

| | | | | |
|----------------|--|---|---|------------|
| DETACHED LISTS | PART NO.: PMM12XXXPPFFSL8XXX00AH | |  宁波高松电子有限公司 NINGBO DEGSON ELECTRICAL CO., LTD | |
| | APPD: | CHKD: | NAME: PM-M12X-XXP-FF-SL8XXX-00A(H) | |
| | DRFT: LRS 2020.09.10 | | TITLE: CUSTOMER DRAWING | REV: D0-3 |
| |  THIRD ANGLE PROJECTION | | DRAWING NO.: XXXXXXXX-XX-CXX | SHEET: 1/2 |
| | |  MM (INCH) | DO NOT SCALE DRAWING | SCALE: 1:1 |

REVISION RECORD

| REV | ECN | DESCRIPTION | DRFT | DATE |
|-----|-----|-------------|------|------|
|-----|-----|-------------|------|------|

H

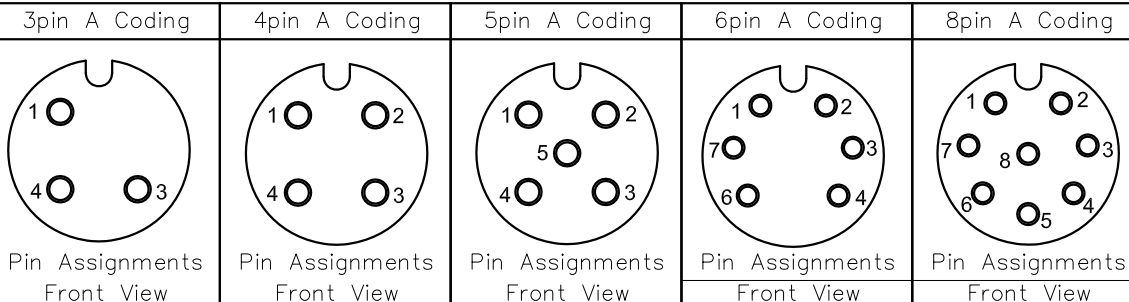

G

Pin Assignments Front View

F

| Pin | Wire Color | Pin | Wire Color | Pin | Wire Color | Pin | Wire Color | Pin | Wire Color |
|-----|------------|-----|------------|-----|------------|-----|------------|-----|------------|
| 8 | Red | 7 | Blue | 6 | Pink | 5 | Grey | 4 | Yellow |
| 7 | Blue | 6 | Pink | 5 | Grey | 4 | Yellow | 3 | Green |
| 6 | Pink | 5 | Grey | 4 | Yellow | 3 | Green | 2 | Brown |
| 5 | Grey | 4 | Yellow | 3 | Green | 2 | Brown | 1 | White |
| 4 | Yellow | 3 | Green | 2 | Brown | 1 | White | | |
| 3 | Green | 2 | Brown | 1 | White | | | | |
| 2 | Brown | 1 | White | | | | | | |
| 1 | White | | | | | | | | |

E

Pin Out

D

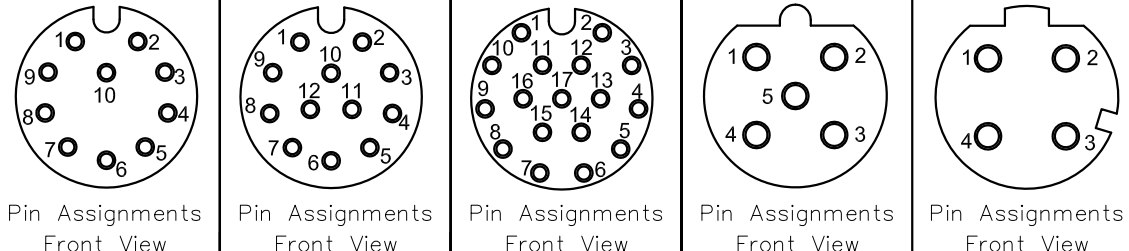

Pin Assignments Front View

C

| | | | | | | | | | |
|----|------------|----|--------------|----|--------------|----|-------------|----|-------------|
| 17 | White/Grey | 16 | Yellow/Brown | 15 | White/Yellow | 14 | Brown/Green | 13 | White/Green |
| 12 | Red/Blue | 11 | Grey/Pink | 10 | Violet | 9 | Red | 8 | Grey |
| 11 | Red/Blue | 10 | Grey/Pink | 9 | Red | 8 | Grey | 7 | Black |
| 10 | Red/Blue | 9 | Red | 8 | Grey | 7 | Black | 6 | Yellow |
| 9 | Red | 8 | Grey | 7 | Black | 6 | Yellow | 5 | Pink |
| 8 | Grey | 7 | Black | 6 | Yellow | 5 | Pink | 4 | Green |
| 7 | Black | 6 | Yellow | 5 | Pink | 4 | Green | 3 | White |
| 6 | Yellow | 5 | Pink | 4 | Green | 3 | White | 2 | Blue |
| 5 | Pink | 4 | Green | 3 | White | 2 | Blue | 1 | Brown |
| 4 | Green | 3 | White | 2 | Blue | 1 | Brown | | |
| 3 | White | 2 | Blue | 1 | Brown | | | | |
| 2 | Blue | 1 | Brown | | | | | | |
| 1 | Brown | | | | | | | | |

B

| Pin | Wire Color | Pin | Wire Color | Pin | Wire Color | Pin | Wire Color | Pin | Wire Color |
|-----|------------|-----|------------|-----|------------|-----|------------|-----|------------|
| 5 | Pink | 4 | Green | 3 | White | 2 | Blue | 1 | Brown |
| 4 | Green | 3 | White | 2 | Blue | 1 | Brown | | |
| 3 | White | 2 | Blue | 1 | Brown | | | | |
| 2 | Blue | 1 | Brown | | | | | | |
| 1 | Brown | | | | | | | | |

A

Pin Out

NOTES:

- Rated voltage/current : 3pin A: 250V / 4A
4pin A: 250V / 4A
5pin A: 60V / 4A
6pin A: 30V / 2A
8pin A: 30V / 2A
10pin A: 30V / 1.5A
12pin A: 30V / 1.5A
17pin A: 30V / 1.5A
5pin B: 60V / 4A
4pin D: 250V / 4A
- Withstanding voltage : 3,4pin A: AC1500V/1Min
5pin A: AC1120V/1Min
6,8pin A: AC500V/1Min
10,12,17pin A: AC500V/1Min
5pin B: AC1120V/1Min
4pin D: AC1500V/1Min
- Levels of protection: IP68
- Cable specifications :
3pin A: 3C*22AWG/0.34mm²,UL2517/UL20549
4pin A: 4C*22AWG/0.34mm²,UL2517/UL20549
5pin A: 5C*22AWG/0.34mm²,UL2517/UL20549
6pin A: 6C*24AWG/0.25mm²,UL2517/UL20549
8pin A: 8C*24AWG/0.25mm²,UL2517/UL20549
10pin A: 10C*26AWG/0.14mm²,UL2517/UL20549
12pin A: 12C*26AWG/0.14mm²,UL2517/UL20549
17pin A: 17C*26AWG/0.14mm²,UL2517/UL20549
5pin B: 5C*22AWG/0.34mm²,UL2517/UL20549
4pin D: 4C*22AWG/0.34mm²,CAT 5E
- Wire connection mode: soldering
- Operating temperature: PVC Cable: -25°C~+85°C
PUR Cable: -25°C~+80°C
- RoHS Compliance
- Tolerance : ±0.5mm

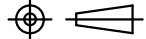
| | | | | |
|--|----------------------------------|------------------------------------|---|----------------------|
| DETACHED LISTS | PART NO.: PMM12XXXPPFFSL8XXX00AH | |  宁波高松电子有限公司 NINGBO DEGSON ELECTRICAL CO., LTD | |
| | APPD: | NAME: PM-M12X-XXP-FF-SL8XXX-00A(H) | | |
| | CHKD: | TITLE: CUSTOMER DRAWING | | |
| | DRFT: LRS 2020.09.10 | REV: D0-3 | SHEET: 2/2 | |
|  THIRD ANGLE PROJECTION | | DRAWING NO.: XXXXXXXX-XX-CXX | SCALE: 1:1 | DO NOT SCALE DRAWING |

H

G

F

E

D

C

B

A